

This service manual is designed for service engineers to repair, adjust, maintain and order the replacement parts of the AU-6600 correctly. When ordering the parts, use the stock number and parts name specifically referring to the Parts Locations & Parts Lists. For general usage and maintenance of the unit, please refer to the Operating Instructions attached with the unit.

TABLE OF CONTENTS

<u>Section</u>	<u>Title</u>	<u>Page</u>
1.	SPECIFICATIONS	2
2.	BLOCK DIAGRAM AND EACH LEVEL	3
3.	ADJUSTMENT	4
3-1.	Driver Circuit Board Adjustment	4
4.	TROUBLESHOOTING CHART	5
4-1.	Troubleshooting on Power Supply Section	5
4-2.	Troubleshooting on Audio Section	5, 6
5.	PARTS LOCATIONS AND PARTS LISTS	7
5-1.	F-2092A Equalizer & Power Supply Circuit Board	7, 8
5-2.	F-2099 Volume Circuit Board	8
5-3.	F-2412 Tone Control Circuit Board	9
5-4.	F-2413 Accessory Switch Circuit Board	10
5-5.	F-2097A Driver & Power Supply Circuit Board	11, 12
5-6.	F-2098 Accessory Switch Circuit Board	13
5-7.	Other Parts (Front Side)	13, 14
5-8.	Other Parts (Top Side)	15
5-9.	Other Parts (Bottom Side)	16
6.	REPLACEMENT OF POWER TRANSISTORS	17
7.	PACKING LIST	17
8.	ACCESSORY PARTS LIST	17
9.	SCHEMATIC DIAGRAM	18

1. SPECIFICATIONS

POWER OUTPUT (at rated distortion)
 CONTINUOUS RMS POWER OUTPUT
 42 Watts per channel × 2
 (both channels driven)
 LOAD IMPEDANCE.....8Ω
 POWER BAND.....20 to 20,000Hz
 TOTAL HARMONIC DISTORTION
 less than 0.15% (from AUX)
 Music power (IHF).....190W (4Ω 1,000Hz)
 120W (8Ω 1,000Hz)
 Continuous rms power output ..45+45W (8Ω 1,000Hz)
 INTERMODULATION DISTORTION (at rated power
 output 70Hz: 7,000Hz=4: 1 SMPTE method)
 OVERALLless than 0.15%
 PREAMPLIFIER ONLYless than 0.1%
 POWER (MAIN) AMPLIFIER ONLY
 less than 0.1%
 FREQUENCY RESPONSE (at 1 Watt output)
 OVERALL10 to 40,000Hz $\pm_{-1}^{+0.5}$ dB
 POWER (MAIN) AMPLIFIER ONLY
 5 to 40,000Hz \pm_{-1}^0 dB
 EQUALIZATION (RIAA curve)
 30 to 15,000Hz ± 0.5 dB
 DAMPING FACTOR30 (8Ω)
 INPUT SENSITIVITY AND INPEDANCE
 (1KHz, for rated power output)
 PHONO2.5mV 50KΩ
 (Max. input capability: 300mV at 0.2% total
 harmonic distortion)
 TUNER100mV 50KΩ
 AUX-1 & -2100mV 50KΩ
 TAPE DECK-1 & -2 (Pin Jacks)....100mV 50KΩ
 TAPE DECK-1 (DIN Socket).....100mV 50KΩ
 MAIN IN800mV 50KΩ
 OUTPUT LEVEL (1KHz)
 TAPE DECK-1 & -2 (Pin Jacks)....100mV
 TAPE DECK-1 (DIN Socket).....30mV
 PRE OUT800mV
 (Max. output level: 5V at 0.5% total harmonic
 distortion)
 CHANNEL SEPARATION (1KHz, at rated power output)
 PHONObetter than 50dB
 TUNERbetter than 55dB
 AUX-1 & -2better than 55dB
 TAPE DECK-1 & -2.....better than 55dB
 MAIN INbetter than 60dB
 HUM AND NOISE (IHF)
 PHONObetter than 70dB
 TUNERbetter than 85dB
 AUX-1 & -2better than 85dB
 TAPE DECK-1 & -2.....better than 85dB
 MAIN INbetter than 100dB

SWITCHES AND CONTROLS
 BASS (±5 steps).....±13dB at 50Hz
 TONE SELECTOR (TURNOVER FREQUENCIES)
 300Hz, 600Hz
 MIDRANGE (±5 steps)..±5dB at 1KHz
 TREBLE (±5 steps).....±13dB at 15KHz
 TONE SELECTOR (TURNOVER FREQUENCIES)
 2KHz, 4KHz
 LOUDNESS (Volume Control: -30dB)
 +10dB at 50Hz
 +8dB at 10KHz
 LOW FILTER-3dB at 70Hz (6dB/oct.)
 HIGH FILTER-3dB at 7KHz (6dB/oct.)
 MUTING-20dB
 OTHERS
 TRANSISTORS.....45
 DIODES16
 ZENER DIODES3
 LED1
 POWER REQUIREMENTS..100, 117, 220, 240V, 50/60Hz
 POWER CONSUMPTION..90W (rated), 260W (max.)
 DIMENSIONS434mm (17 $\frac{1}{8}$ ") W
 130mm (5 $\frac{1}{8}$ ") H
 315mm (12 $\frac{1}{16}$ ") D
 WEIGHT11.3Kg (24.9 lbs) Net
 13.0Kg (28.7 lbs) Packed

* Design and specifications subject to change without notice for improvements.

2. BLOCK DIAGRAM AND VALUE OF EACH LEVEL

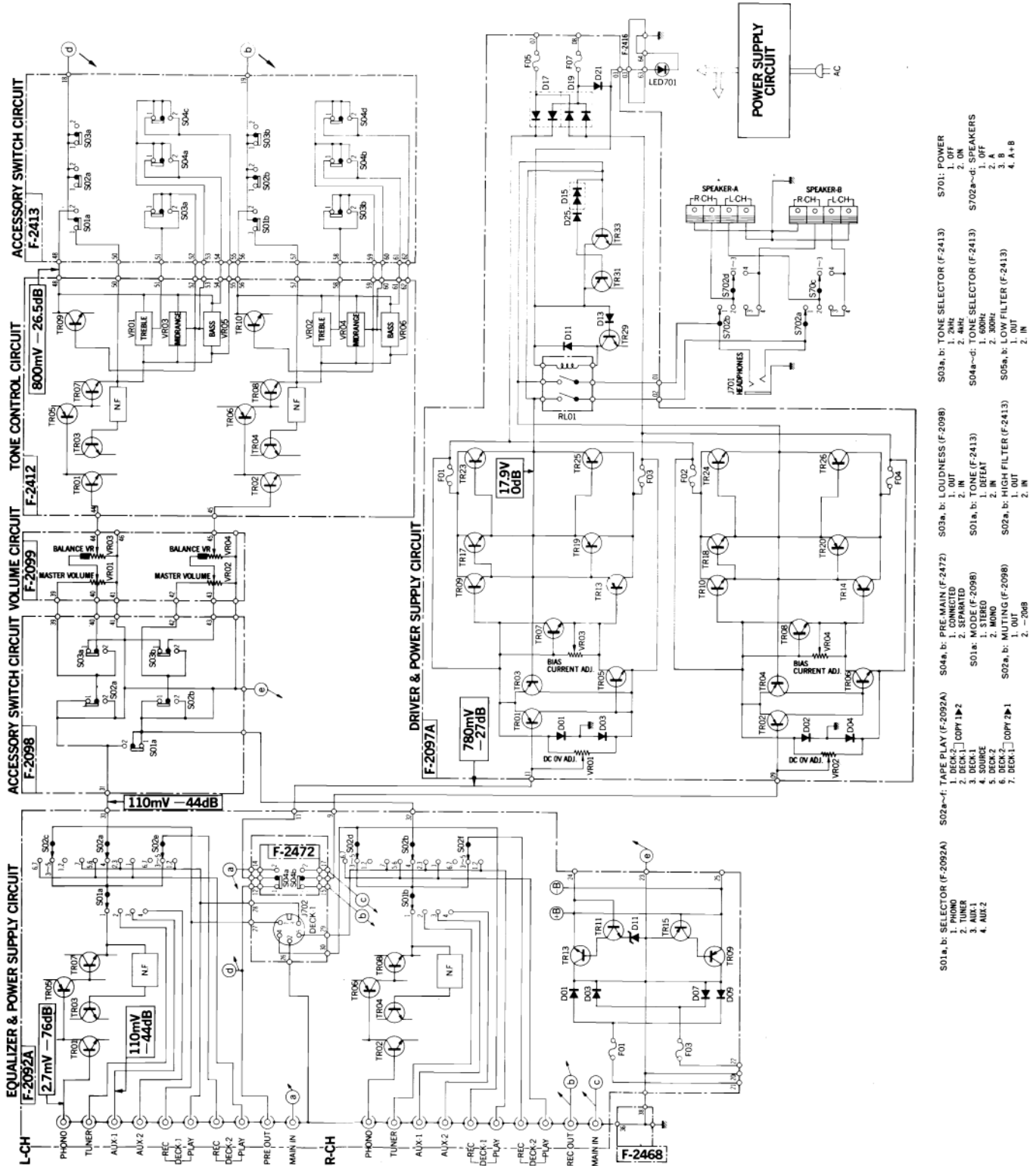

- S01a, b: SELECTOR (F-2092A)
 1. PHONO
 2. TUNER
 3. AUX.1
 4. AUX.2
- S02a-f: TAPE PLAY (F-2092A)
 1. TAPE
 2. DECK 1
 3. DECK 2
 4. SOURCE
 5. DECK 2
 6. DECK 1
 7. DECK 1
- S02a, b: COPY 2-1
 1. COPY 1
 2. COPY 2
- S04a, b: PRE MAIN (F-2472)
 1. MONO
 2. SEPARATED
- S01a, b: MODE (F-2098)
 1. STEREO
 2. MONO
- S02a, b: MULTING (F-2098)
 1. OFF
 2. ON
- S03a, b: LOUDNESS (F-2098)
 1. OUT
 2. IN
- S01a, b: TONE (F-2413)
 1. DEFEAT
 2. IN
- S02a, b: HIGH FILTER (F-2413)
 1. OFF
 2. ON
- S03a, b: TONE SELECTOR (F-2413)
 1. OFF
 2. ON
- S04a-d: TONE SELECTOR (F-2413)
 1. OFF
 2. A
 3. B
 4. A+B
- S05a, b: LOW FILTER (F-2413)
 1. OFF
 2. ON
- S701: POWER
 1. OFF
 2. ON
- S702a-d: SPEAKERS
 1. OFF
 2. A
 3. B
 4. A+B

3. ADJUSTMENT

3-1. Driver Circuit Board Adjustment (See Fig. 3-1 and 3-2)

- Note:**
1. Confirm the AC power supply voltage.
 2. MASTER VOLUMEMinimum
 3. SPEAKERS SelectorA
 4. Make the SP terminals free (no load).
 5. For adjustment, run the unit for more than 3 minutes after the power is switched ON.
 6. Room temperature should be 18~28°C (65~83°F) for bias current adjustment.

STEP	SUBJECT	EQUIPMENT	MEASURE OUTPUT	ADJUST	ADJUST FOR	CONDITION
1	DC 0V L-ch	DC volt meter	SP terminal L-ch (See Fig. 3-2)	F-2097A VR01	0V ± 10mV	◦Turn volumes of VR03, VR04 CCW
2	DC 0V R-ch	Same as above	SP terminal R-ch (See Fig. 3-2)	F-2097A VR02	Same as above	
3	Bias current L-ch	DC milliammeter	F-2097A F01 (See Fig. 3-1)	F-2097A VR03	25 ± 10mA	◦Step down meter's range accordingly
4	Bias current R-ch	Same as above	F-2097A F02 (See Fig. 3-1)	F-2097A VR04	Same as above	

Fig. 3-1

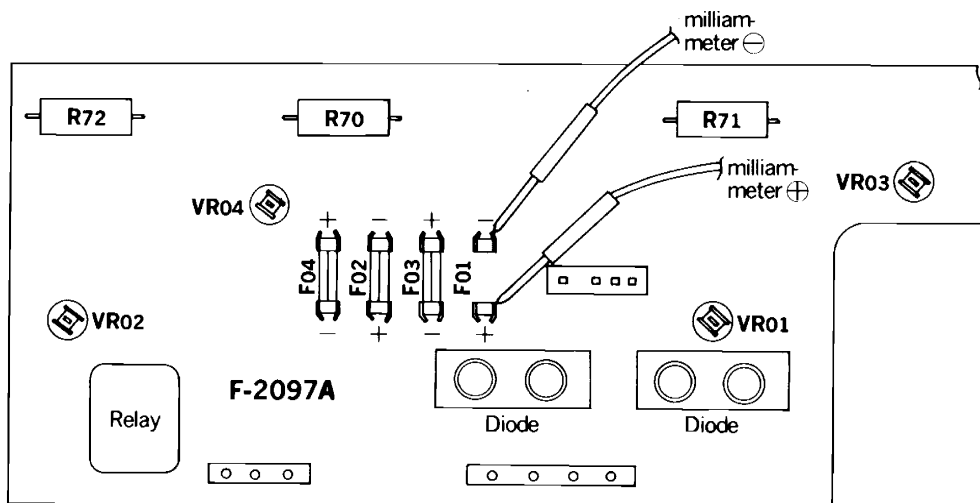
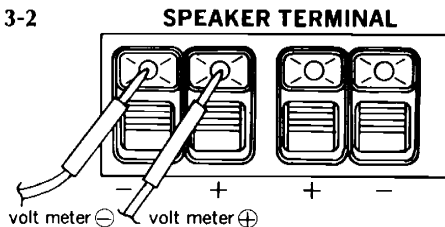

Fig. 3-2



Condition of Level Measuring

*Value of each level in block diagram was measured by the followings.

1. MASTER VOLUME controlMaximum
2. BASS, MIDRANGE, TREBLE & BALANCE volume controlsCenter
3. TONE & FILTER switch control.....IN
4. InputPHONO-1 2.7mV 1kHz Sine Wave
AUX-1, 2 110mV 1kHz Sine Wave

(output impedance of 600Ω at an audio oscillator)

5. Output17.9V (40W) 8Ω
- Note:** Each voltage value is for reference and measured by a VTVM. In some recorders, the actual voltage value is in minor difference from the reference value.

4. TROUBLESHOOTING CHART

4-1. Troubleshooting on Power Supply Section

Symptom	Check Point	Cause & What to Do
1. No power supplied to each section		
1-1. Indicator lamp for power not lighted		1. Power supply cord open 2. Imperfect contact of power switch, S701 3. Power fuse, F701 open 4. Defective power transformer, T701 5. F07 on F-2097A open 6. Defective D21 on F-2097A 7. Imperfect contact of voltage selector, PU01
1-2. Indicator lamp for power lighted		
1) $\pm 40V$ not supplied to collector on each power transistor (+40V, TR23, TR24, -40V, TR25, TR26)		8. F05 or F07 on F-2097A open 9. Defective D17 or D19 on F-2097A
2) +24V not supplied to terminal 24 and -25V not supplied to terminal 25 on F-2092A		10. Defective power transformer, T701 11. F01 or F03 on F-2092A open 12. Defective D01, D03, D07 or D09 on F-2092A 13. Defective TR09, TR11, TR13 or TR15 on F-2092A 14. Defective D11 on F-2092A

4-2. Troubleshooting on Audio Section

1. Quick acting fuse open

1-1. After replacement, F01 (F02) on F-2097A open again		1. Defective TR23 (TR24) on F-2097A 2. Defective TR09 or TR17 (TR10 or TR18) on F-2097A
1-2. After replacement, F03 (F04) on F-2097A open again		3. Defective TR25 (TR26) on F-2097A 4. Defective TR13 or TR19 (TR14 or TR20) on F-2097A
1-3. After replacement, fuse not open		
1) Bias current adjustable		5. Set the bias current to +25mA by VR03 (VR04) on F-2097A (refer to 3. ADJUSTMENT on page 4)
2) Bias current adjustable		6. Defective VR03 (VR04) on F-2097A 7. Defective TR05 or TR07 (TR06 or TR08) on F-2097A
3) Center voltage adjustable		8. Set the center voltage to 0V by VR01 (VR02) on F-2097A (refer to 3. ADJUSTMENT on page 4)
4) Center voltage not adjustable		9. Defective VR01 (VR02) on F-2097A 10. Defective TR05 (TR06) on F-2097A 11. Defective D01 or D03 (D02 or D04) on F-2097A

Symptom	Check Point	Cause & What to Do
2. TUNER or AUX inoperative		
2-1. Both channels inoperative		<ul style="list-style-type: none"> 1. Defective relay, RL01 on F-2097A 2. Imperfect contact of SPEAKERS switch, S702a, c (S702b, d) 3. Defective TR29, TR31 or TR33 on F-2097A 4. Defective D13, D23 or D25 on F-2097A 5. Defective Power Supply Section
2-2. One channel inoperative		
	※ Set MODE switch to MONO	
1) Inoperative channel reverses		<ul style="list-style-type: none"> 6. Tuner connected from this set has faulty 7. Imperfect contact of SELECTOR switch, S01a (S01b) 8. Imperfect contact of TAPE PLAY switch, S02a (S02b)
2) Inoperative channel not reverses		
	※ Set TONE switch to DEFEAT	
2-1) The inoperative channel becomes operating		9. Defective TR09 (TR10) on F-2412
2-2) The inoperative channel is still not operating		<ul style="list-style-type: none"> 10. Defective TR01, TR03, TR05 or TR07 (TR02, TR04, TR06 or TR08) on F-2412 11. Imperfect contact of HIGH FILTER switch S02a (S02b) 12. Imperfect contact of TONE SELECTOR switch, S03a (S03b) 13. Imperfect contact of PRE-MAIN switch, S04a (S04b) 14. Defective Driver & Power Supply circuit board
3. PHONO inoperative		
3-1. Both channels inoperative		1. Refer to 2-1. of 2. Both channels inoperative
3-2. One channel inoperative		
	※ Set MODE switch to MONO	
1) Inoperative channel reverses		<ul style="list-style-type: none"> 2. Turntable connected from this set has faulty 3. Defective TR01, TR03, TR05 or TR07 (TR02, TR04, TR06 or TR08) on F-2092A
2) Inoperative channel not reverses		4. Refer to 2-2. of 2. One channel inoperative

5. PARTS LOCATIONS AND PARTS LISTS

5-1. F-2092A Equalizer & Power Supply Circuit Board

Conductor Side

(Stock No. 7550590 Complete Circuit Board F-2092A)

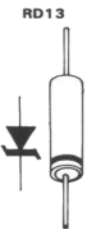
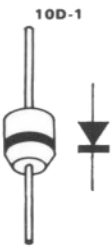
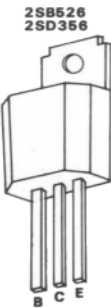
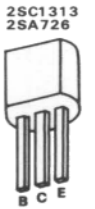
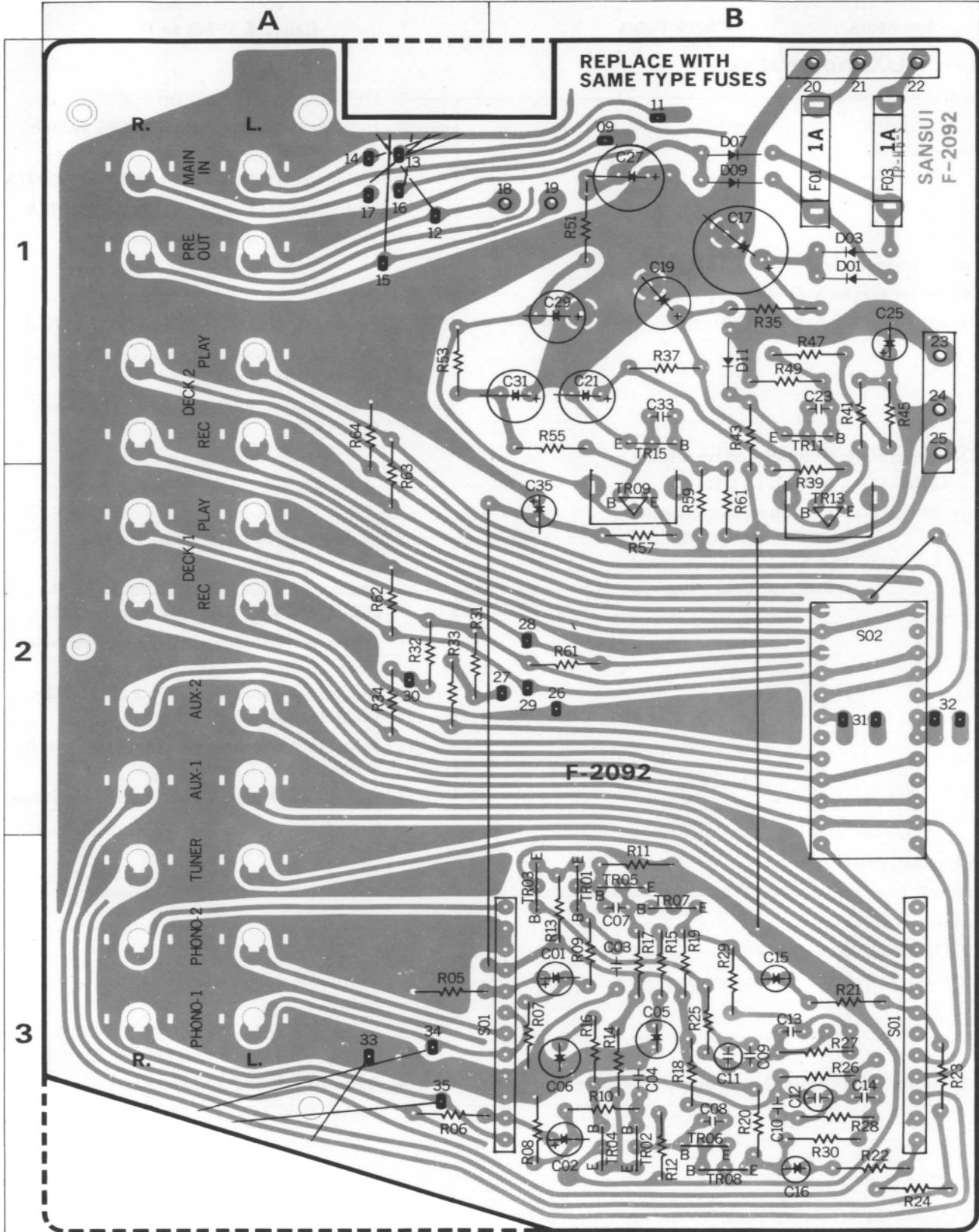

Parts List

Parts No.	Stock No.	Description	Position	
TR01, 02	0306071, 2	2SC1313 (R) (G, H)	} Transistor	3 B
TR03, 04	0306071, 2	2SC1313 (R) (G, H)		3 B
TR05, 06	0300470, 1	2SA726 (W) (F, G)		3 B
TR07, 08	0306070-2	2SC1313 (R) (F, G, H)		3 B
TR09	0303280-2	2SB526 (C, D, E)		2 B
TR11	0306070-2	2SC1313 (R) (F, G, H)		1 B
TR13	0308450-2	2SD356 (C, D, E)	2 B	
TR15	0300470, 1	2SA726 (W) (F, G)		2 B
D01	0310340	10D-1	} Diode	1 B
D03	0310340	10D-1		1 B
D07	0310340	10D-1		1 B
D09	0310340	10D-1		1 B
D11	0316316	RD13E(B)		1 B
C01, 02	0519103	0.47µF 50V E.C.		2 B
C03, 04	0660330	33pF 50V C.C.		2 B
C05, 06	0532100	10µF 16V BP.E.C.		2 B
C07, 08	0660470	47pF 50V C.C.		2 B
C09, 10	0600826	0.0082µF 50V M.C.		2 B
C11, 12	0621561	560pF 50V P.C.		2 B
C13, 14	0600276	0.0027µF 50V M.C.		2 B
C15, 16	0533339	3.3µF 25V E.C.		2 B
C17	0515221	220µF 50V E.C.		1 B
C19	0514101	100µF 35V E.C.		1 B
C21	0515470	47µF 50V E.C.		1 B
C23	0660221	220pF 50V C.C.		1 B
C25	0513100	10µF 25V E.C.		1 B
C27	0515101	100µF		1 B
C29	0515470	47µF	} 50V E.C.	1 B
C31	0515470	47µF		1 A, B
C33	0660221	220pF 50V C.C.		1 B
C35	0513479	4.7µF 25V E.C.		2 B
C901, 902	0601107	0.01µF 50V M.C.		
C903, 904	0515339	3.3µF 50V E.C.		
C905, 906	0657223	0.022µF	} 50V C.C.	
C907, 908	0660101	100 pF		
R05, 06	0107683	68kΩ	} 1/4W C.R.	3 A
R07, 08	0107224	220kΩ		3 B
R09, 10	0107152	1.5kΩ		3 B
R11, 12	0107822	8.2kΩ		3 B
R13, 14	0107124	120kΩ		3 B
R15, 16	0107821	820Ω		3 B
R17, 18	0107223	22kΩ		3 B
R19, 20	0107472	4.7kΩ		3 B
R21, 22	0107101	100Ω		3 B
R23, 24	0107563	56kΩ		3 B
R25, 26	0107474	470kΩ	3 B	
R27, 28	0107273	27kΩ	3 B	
R29, 30	0107561	560Ω	3 B	
R31, 32	0107104	100kΩ	2 A	
R33, 34	0107224	220kΩ	2 A	
R35	0104181	180Ω	} 1 W C.R.	1 B
R37	0107272	2.7kΩ		1 B
R39	0107821	820Ω	2 B	
R41	0107220	22Ω	1 B	
R43	0107821	820Ω	} 1/4W C.R.	1, 2 B
R45	0107392	3.9kΩ		1 B
R47	0107471	470Ω	1 B	
R49	0107682	6.8kΩ	1 B	
R51	0103331	330Ω	1/2W C.R.	1 B
R53	0107392	3.9kΩ	1/4W C.R.	1 A

Parts No.	Stock No.	Description	Position		
R55	0107122	1.2kΩ	} 1/4W C.R.	1 B	
R57	0107330	33Ω		2 B	
R59	0107153	15kΩ		2 B	
R61	0107153	15kΩ		2 B	
R61	0107474	470kΩ		2 B	
R62	0107474	470kΩ		2 A	
R63	0107474	470kΩ		1, 2 A	
R64	0107474	470kΩ		1, 2 A	
S01	1101540	SRE-1-2-4		} Rotary Switch	3 B
S02	1102560	SRE-2-6-7			2, 3 B
F01	0430830	1A (20m/m)	} Fuse	1 B	
F03	0430830	1A (20m/m)		1 B	
	2310150	Fuse Holder			
	2430250	Pin Jack			
	5936691	Heat Sink			

5-2. F-2099 Volume Circuit Board Conductor Side

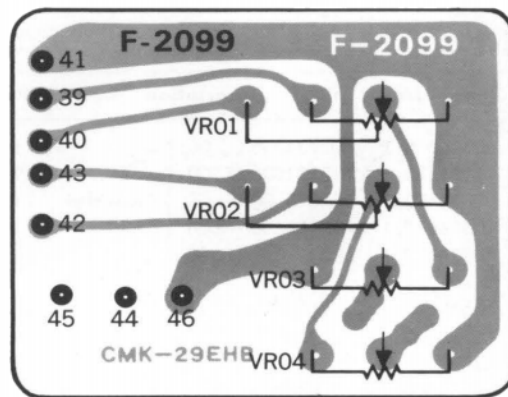

Parts List

Parts No.	Stock No.	Description
VR01-04	1060320	250kΩ (MN, B) × Volume

Abbreviations

C.R. : Carbon Resistor	BP.E.C.: Bi-Polar Electrolytic Capacitor
S.R. : Solid Resistor	C.C. : Ceramic Capacitor
Ce.R. : Cement Resistor	Mi.C. : Mica Capacitor
M.R. : Metallized Film Resistor	O.C. : Oil Capacitor
M.C. : Mylar Capacitor	P.C. : Polystyrene Capacitor
E.C. : Electrolytic Capacitor	T.C. : Tantalum Capacitor

5-3. F-2412 Tone Control Circuit Board (Stock No. 7560830 Complete Circuit Board F-2412)

Conductor Side

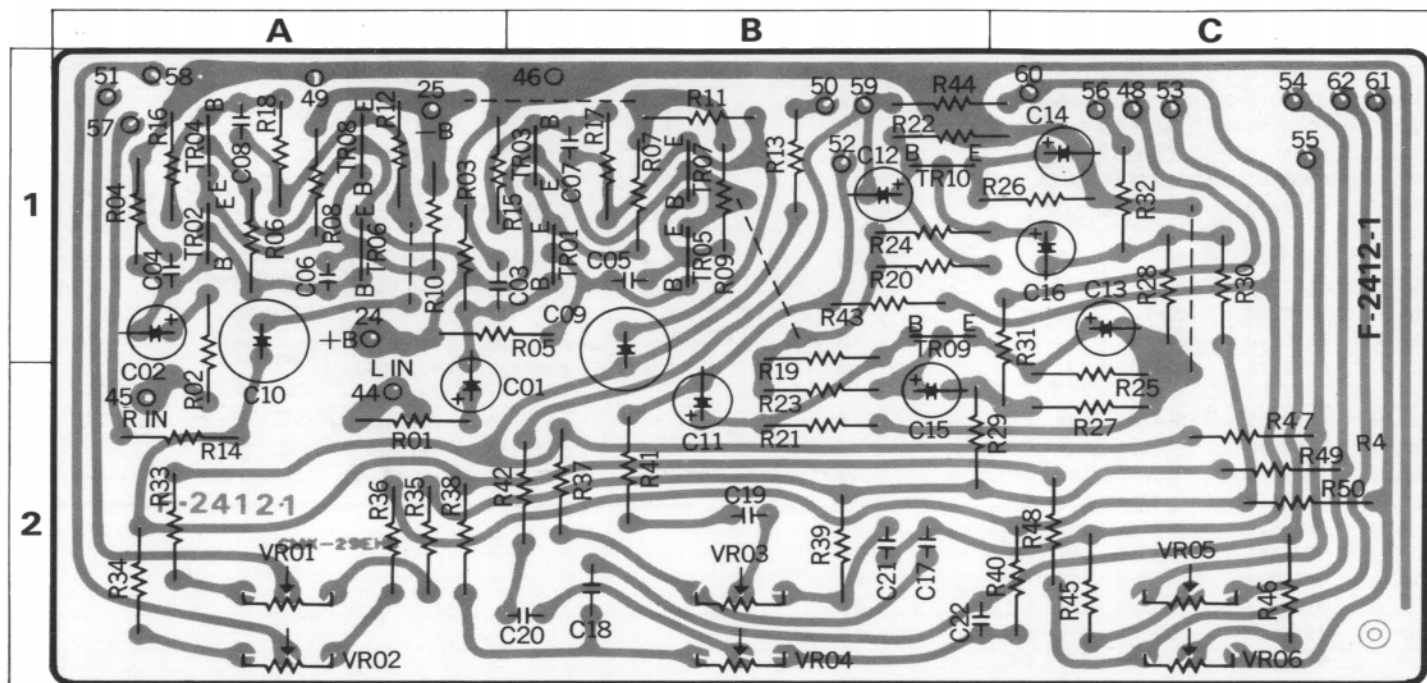

Parts List

Parts No.	Stock No.	Description	Position	
TR01, 02	0306070, 1	2SC1313® (F, G)	} Transistor 1 B . 1 A	
TR03, 04	0306070, 1	2SC1313® (F, G)		
TR05, 06	0300470, 1	2SA726 ® (F, G)		
TR07, 08	0306070, 1	2SC1313® (F, G)		
TR09, 10	0306070, 1	2SC1313® (F, G)		
C01, 02	0519103	0.47 µF 50V E.C.	1,2A . 1 A	
C03, 04	0660330	33pF	1 A	
C05, 06	0660220	22pF	} 50V C.C. 1 B . 1, 2B	
C07, 08	0660680	68pF		
C09, 10	0533220	22 µF 25V BP.E.C.	1 A . 1,2A	
C11, 12	0519101	1 µF 50V E.C.	2 B . 1 B	
C13, 14	0510470	47 µF 6.3V E.C.	1 C	
C15, 16	0519001	10 µF 25V E.C.	2 B . 1 C	
C17, 18	0601686	0.0068 µF	} 50V M.C. 2 B	
C19, 20	0601476	0.0047 µF		
C21, 22	0601686	0.0068 µF		
C901, 902	0601107	0.01 µF		
C903, 904	0660150	15 pF	} 50V C.C. 2 B	
C905	0657223	0.022 µF		
R01, 02	0107222	2.2k Ω	} ¼W C.R. 2 A . 1,2A	
R03, 04	0107124	120k Ω		
R05, 06	0107822	8.2k Ω		
R07, 08	0107124	120k Ω		
R09, 10	0107223	22k Ω		
R11, 12	0107472	4.7k Ω		
R13, 14	0107101	100 Ω		
R15, 16	0107222	22k Ω		
R17, 18	0107183	18k Ω		
R19, 20	0107334	330k Ω		} ¼W C.R. 1 B
R21, 22	0107683	68k Ω		
R23, 24	0107222	2.2k Ω		
R25, 26	0107471	470 Ω		
R27, 28	0107104	100k Ω		
R29, 30	0107101	100 Ω		
R31, 32	0107101	100 Ω		
R33, 34	0107272	2.7k Ω		
R35, 36	0107272	2.7k Ω		
R37, 38	0107472	4.7k Ω		
R39, 40	0107472	4.7k Ω		
R41, 42	0107273	27k Ω		
R43, 44	0107223	22k Ω		
R45, 46	0107471	470 Ω		
R47, 48	0107822	8.2k Ω		
R49, 50	0107822	8.2k Ω		
VR01, 02	1015110, 1	50k Ω (B) × 2	} Variable Resistor 2 A	
VR03, 04	1015110, 1	50k Ω (B) × 2		
VR05, 06	1015110, 1	50k Ω (B) × 2		

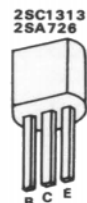

5-4. F-2413 Accessory Switch Circuit Board (Stock No. 7592150 Complete Circuit Board F-2413)

Conductor Side

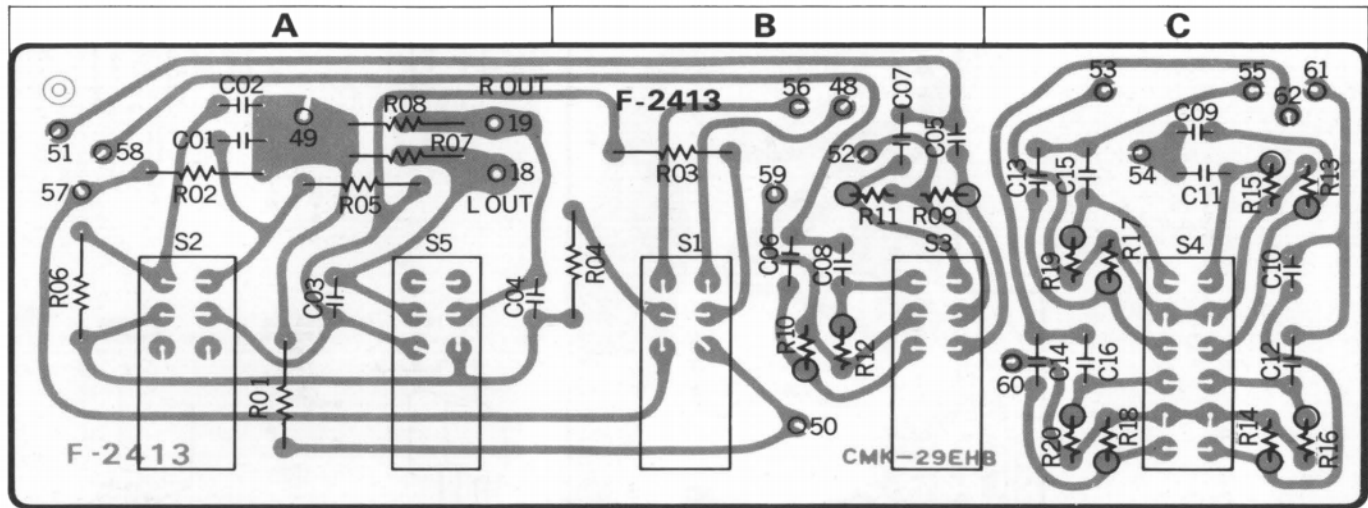

Parts List

Parts No.	Stock No.	Description	Position
C01, 02	0601686	0.0068 μ F	A
C03, 04	0601477	0.047 μ F	A
C05, 06	0601226	0.0022 μ F	B
C07, 08	0601126	0.0012 μ F	B
C09, 10	0601686	0.0068 μ F	B
C11, 12	0601227	0.022 μ F	B
C13, 14	0601686	0.0068 μ F	B
C15, 16	0601227	0.022 μ F	B
R01, 02	0107104	100k Ω	A
R03, 04	0107332	3.3k Ω	B
R05, 06	0107824	820k Ω	A
R07, 08	0107104	100k Ω	A
R09, 10	0106105	1M Ω	B
R11, 12	0106105	1M Ω	B
R13, 14	0106105	1M Ω	B
R15, 16	0106105	1M Ω	B
R17, 18	0106105	1M Ω	C, B
R19, 20	0106105	1M Ω	B
S01-03	1170340	SX15-5	Lever Switch
S04	1170360	SX15-7	
S05	1170340	SX15-5	

Abbreviations

C.R. :	Carbon Resistor	BP.E.C.:	Bi-Polar Electrolytic Capacitor
S.R. :	Solid Resistor	C.C. :	Ceramic Capacitor
Ce.R. :	Cement Resistor	Mi.C. :	Mica Capacitor
M.R. :	Metallized Film Resistor	O.C. :	Oil Capacitor
M.C. :	Mylar Capacitor	P.C. :	Polystyrene Capacitor
E.C. :	Electrolytic Capacitor	T.C. :	Tantalum Capacitor

5-5. F-2097A Driver & Power Supply Circuit Board

Conductor Side

(Stock No. 7570920 Complete Circuit Board F-2097A)

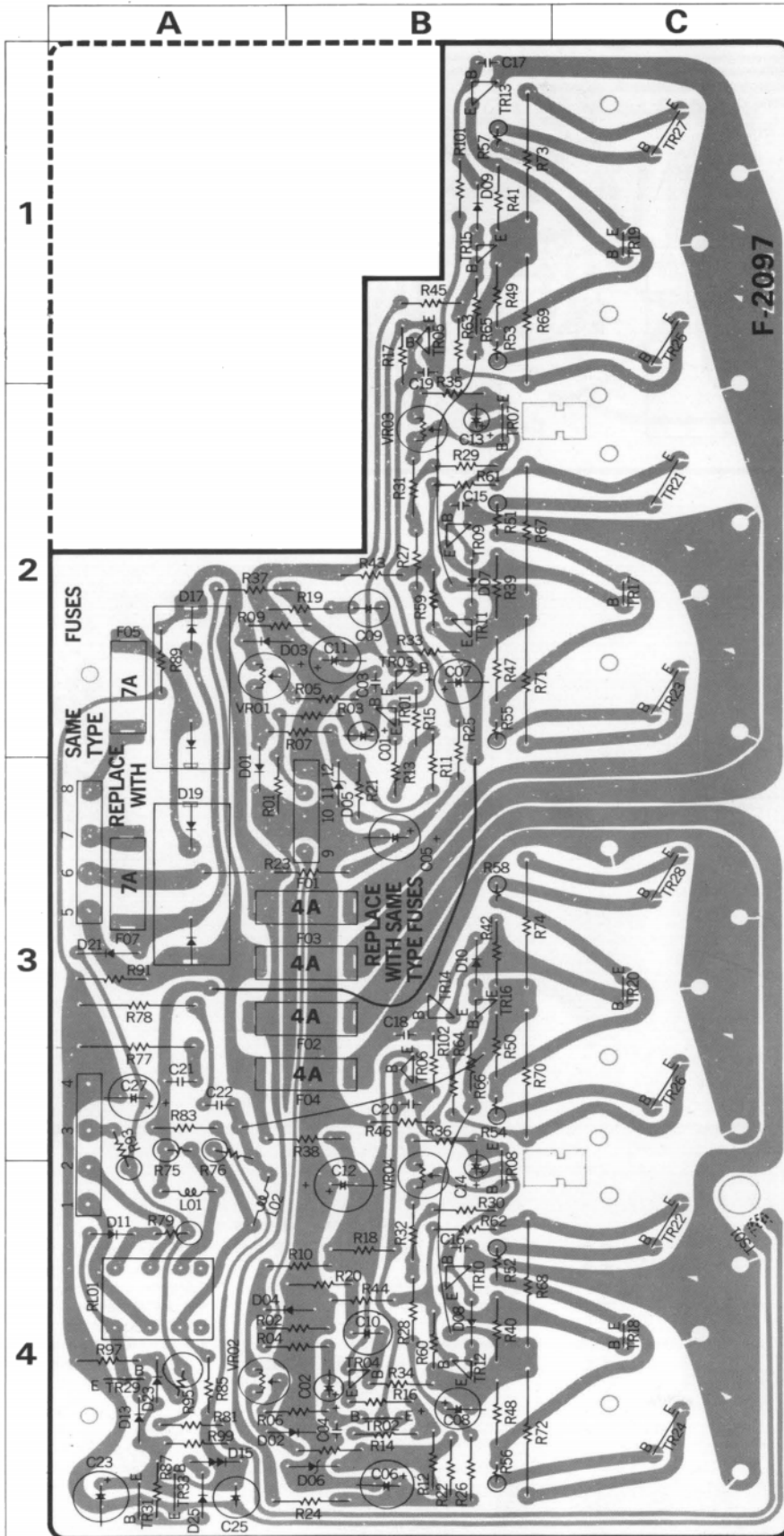

2SA726
2SC711



2SA806
2SC959



2SC1384
2SA733
2SC945

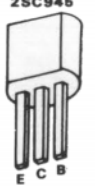

2SC1124

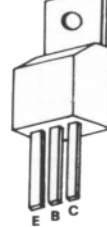

2SA758
2SC898

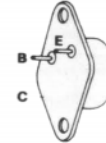

2SD382
2SB537

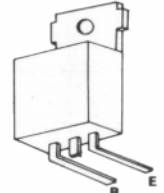

1S953



10D-1

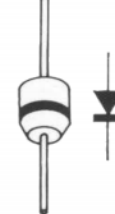

1N-60

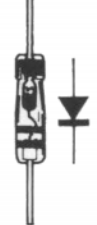

SV-02



DS-430

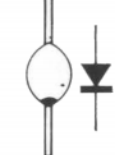

1S953



SS-3

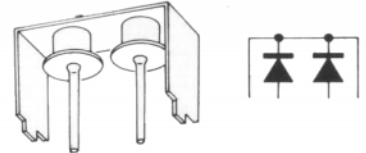

SS-3R

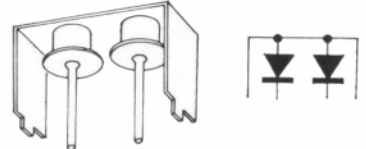

Parts List

Parts No.	Stock No.	Description	Position	
TR01, 02	0300470, 1	2SA726 (F, G)	} Transistor	
TR03, 04	0300470, 1	2SA726 (F, G)		
TR05, 06	0305900, 1	2SC1124 (1, 2)		
TR07, 08	0305731~3	2SC711 (E, F, G)		
TR09, 10	0305742, 3	2SC959 (L, K)		
TR13, 14	0300212, 3	2SA606 (L, K)		
TR17, 18	0308441, 2	2SD382 (M, L)		
TR19, 20	0303271, 2	2SB537 (M, L)		
TR23, 24	0305701	2SC898 (B)		
TR25, 26	0300671, 2	2SA758 (B, C)		
TR29	0306130~2	2SC1364 (5, 6, 7)		
TR31	0300510~2	2SA733 (P, Q, R)	4 A	
TR33	0305950~2	2SC945 (R, Q, P)	4 A	
D01, 02	0340090	DS-430	} Diode	
D03, 04	0340090	DS-430		
D05, 06	0316230	RD-9.1E(B)		
D11	0310340	10D-1		
D13	0311050	1S953		
D15	0310490	SV-02		
D17	0311290	SS-3		
D19	0311300	SS-3R		
D21	0310340	10D-1		
D23	0310331	1N60		
D25	0340090	DS-430		
C01, 02	0519101	1 μ F 50V E.C.	2 B . 4 B	
C03, 04	0660470	47pF 50V C.C.	2 B . 4 B	
C05, 06	0515101	100 μ F } 50V E.C.	3 A . 4 B	
C07, 08	0515470	47 μ F } 50V E.C.	2 B . 4 B	
C09, 10	0530470	47 μ F 6.3V E.C.	2 B . 4 B	
C11, 12	0515101	100 μ F } 50V E.C.	2 B . 4 B	
C13, 14	0515109	1 μ F } 50V E.C.	2 B . 4A, B	
C15, 16	0660100	10pF } 50V C.C.	2 B . 4 B	
C17, 18	0660100	10pF } 50V C.C.	1 B . 3 A	
C19, 20	0660220	22pF } 50V C.C.	1 B . 3 A	
C21, 22	0601687	0.068 μ F 50V M.C.	3 A	
C23	0510471	470 μ F 6.3V E.C.	4 A	
C25	0531101	100 μ F 10V E.C.	4 A	
C27	0515330	33 μ F 50V E.C.	3 A	
C901	0601106	0.001 μ F } 50V M.C.	}	
C902, 903	0601107	0.01 μ F } 50V M.C.		
R01, 02	0107474	470k Ω	} $\frac{1}{4}$ W C.R.	
R03, 04	0107103	10k Ω		
R05, 06	0107104	100k Ω		
R07, 08	0107822	8.2k Ω		
R09, 10	0107393	39k Ω		
R11, 12	0107332	3.3k Ω		
R13, 14	0107100	10 Ω		
R15, 16	0107100	10 Ω		
R17, 18	0107821	820 Ω		
R19, 20	0107332	3.3k Ω		
R21, 22	0103472	4.7k Ω		
R23, 24	0103181	180 Ω	} $\frac{1}{2}$ W C.R.	
R25, 26	0103102	1k Ω		
R27, 28	0103472	4.7k Ω		
R29, 30	0107390	39 Ω		
R31, 32	0107682	6.8k Ω		
R33, 34	0107582	82k Ω		} $\frac{1}{4}$ W C.R.
R35, 36	0107122	1.2k Ω		
R37, 38	0103101	100 Ω		} $\frac{1}{2}$ W C.R.
R39, 40	0103102	1k Ω		

Parts No.	Stock No.	Description	Position
R41, 42	0103102	1k Ω $\frac{1}{2}$ W C.R.	1 B . 3 B
R47, 48	0103101	100 Ω	} $\frac{1}{2}$ W C.R.
R49, 50	0103101	100 Ω	
R53, 54	0103100	10 Ω	
R55, 56	0103100	10 Ω	
R69, 70	0133478	0.47 Ω	} 3W Ce.R.
R71, 72	0133478	0.47 Ω	
R75, 76	0104479	4.7 Ω 1W C.R.	3 A
R77, 78	0105100	10 Ω 2W C.R.	3 A
R79	0104181	180 Ω 1W C.R.	4 A
R81	0107823	82k Ω	} $\frac{1}{4}$ W C.R.
R83	0107823	82k Ω	
R85	0107104	100k Ω	
R87	0107473	47k Ω	
R89	0103562	5.6k Ω	} $\frac{1}{2}$ W C.R.
R91	0103562	5.6k Ω	
R93	0105182	1.8k Ω	} 2W C.R.
R95	0105182	1.8k Ω	
R97	0107221	220 Ω	} $\frac{1}{4}$ W C.R.
R99	0107223	22k Ω	
R909	0107102	1k Ω	4 A
RL01	1150251	RABK-2B Relay	4 A
L101, 102	4290210	2.5 μ H Micro Inductor	4 A, B
VR01, 02	1035110	4.7k Ω (B) } Semi Variable	} Resistor
VR03, 04	1035070	1k Ω (B) }	
F01~04	0433630	4A Quick Acting Fuse	3 A, B
F05, 07	0430920	7A 20m/m Power Fuse	2 A, 3 A
	5937061	Heat Sink	
	2310150	Fuse Holder	

== Abbreviations ==

C.R. : Carbon Resistor	BP.E.C.: Bi-Polar Electrolytic Capacitor
S.R. : Solid Resistor	C.C. : Ceramic Capacitor
Ce.R. : Cement Resistor	M.C. : Mica Capacitor
M.R. : Metallized Film Resistor	O.C. : Oil Capacitor
M.C. : Mylar Capacitor	P.C. : Polystyrene Capacitor
E.C. : Electrolytic Capacitor	T.C. : Tantalum Capacitor

5-6. F-2098 Accessory Switch Circuit Board

(Stock No. 7592170 Complete Circuit Board F-2098)

Conductor Side

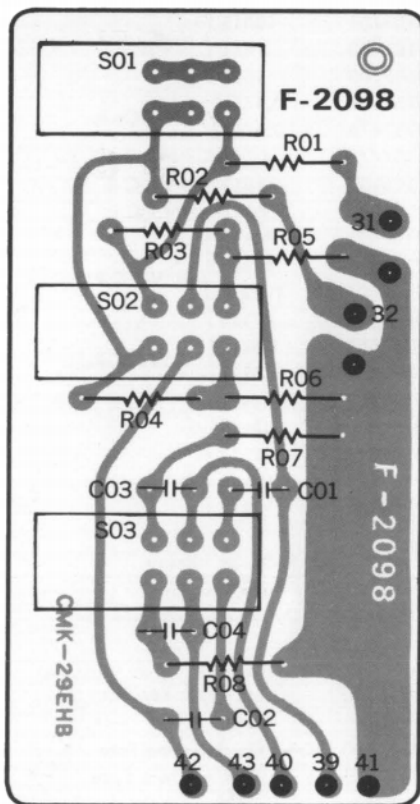

Parts List

Parts No.	Stock No.	Description
C01, 02	0660391	390 pF 50V C.C.
C03, 04	0601227	0.022 μF 50V M.C.
R01, 02	0107103	10kΩ
R03, 04	0107474	470kΩ
R05, 06	0107823	82kΩ
R07, 08	0107223	22kΩ
		1/4W C.R.
S01-03	1170340	SX15-5 Lever Switch

5-7. Other Parts (Front Side) Parts List

Parts No.	Stock No.	Description
1	5101161	Binding Head Screw, M4×6
2	5109222	Binding Head Tapping Screw, M3×8
3	5309270	Side Panel (Right)
4	5109121	Binding Head Tapping Screw, M3×6
5	5269830	Side Panel Retainer
6	5309260	Side Panel (Left)
7	5109222	Binding Head Tapping Screw, M3×8
8	5122540	Toothed Lock Washer (External), 3φ
9	5006340	Metal Bonnet
10	5317880	S-5 Type Knob
11	5318041	S-5 Type Knob (Tone Control)
12	5326460	E-1 Type Knob
13	5318001	W0-3 Type Knob (Volume)
14	5318080	U-5 Type Knob (Balance)
15	5109222	Binding Head Tapping Screw, M3×8
16	{ 5309220	Front Panel
	{ 5269800	Holder (Light Emitted Diode)
17	5109222	Binding Head Tapping Screw, M3×8
18	5269880	Stopper (Front Panel)
19	7726080	Light Emitted Diode (SDB-501A-RD)
20	1101560, 1	Rotary Switch Y-1-4-4 (Speakers)
21	1015110, 1	50kΩ (B)×2 Tone Control Volume
22	1170330	Lever Switch (Power)
23	2430190	Headphones Jack
24	1170340	Lever Switch
25	1170360	Lever Switch
26	1060320	250kΩ (MN, B)×4 Volume, Balance Volume
27	1102560	Rotary Switch SRE-2-6-7 (Tape Play)
28	1101540	Rotary Switch SRE-1-2-4 (Selector)
29	5109222	Binding Head Tapping Screw, M3×8
30	5166520	Washer Head Tapping Screw, M3×12
31	5516940	Foot
32	5058221	Bottom Plate
33	5047460	Masking (Lever Switch)

Abbreviations

C.R. : Carbon Resistor	BP.E.C.: Bi-Polar Electrolytic Capacitor
S.R. : Solid Resistor	C.C. : Ceramic Capacitor
Ce.R. : Cement Resistor	Mi.C. : Mica Capacitor
M.R. : Metallized Film Resistor	O.C. : Oil Capacitor
M.C. : Mylar Capacitor	P.C. : Polystyrene Capacitor
E.C. : Electrolytic Capacitor	T.C. : Tantalum Capacitor

5-8. Other Parts (Top Side)

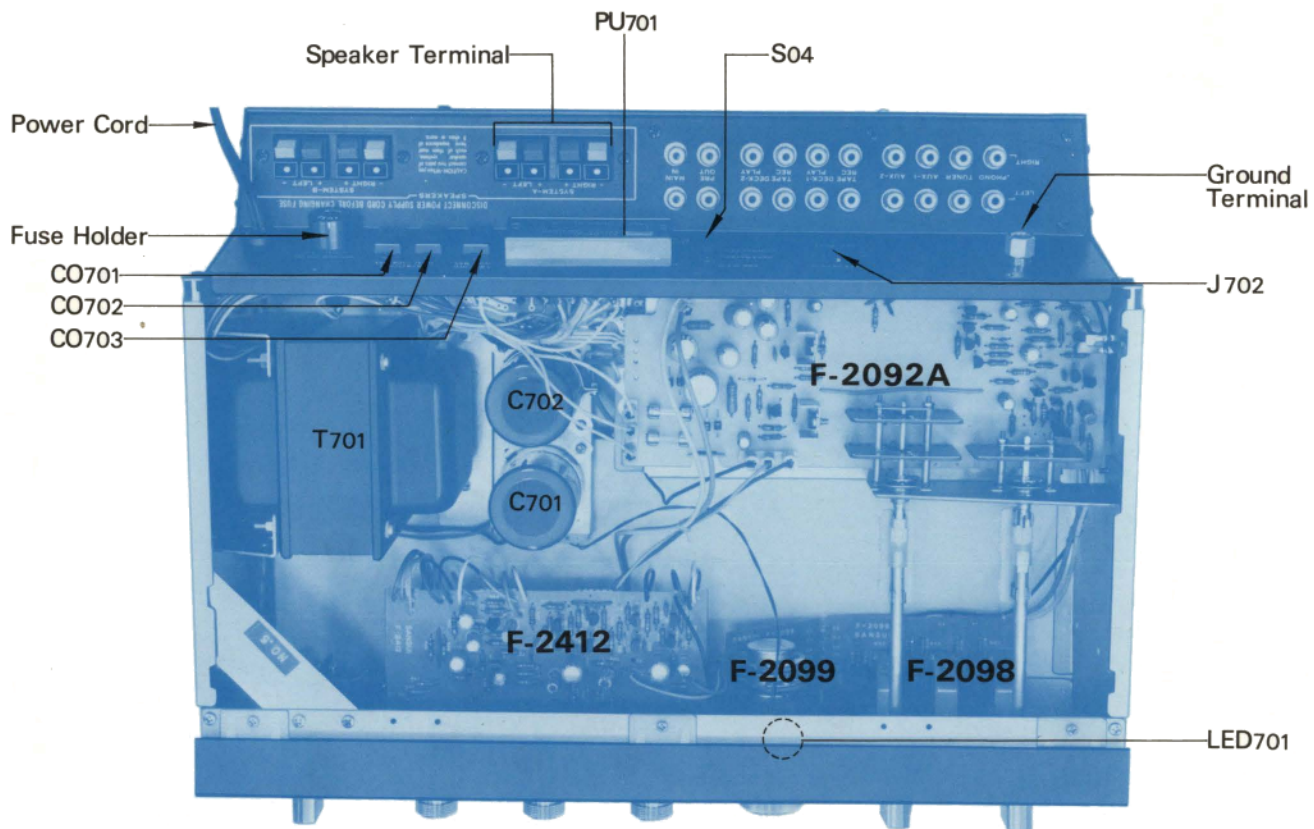

Parts List

Parts No.	Stock No.	Description
C701	0559321	6800 μ F } -50V E.C.
C702	0559321	
LED701	7726080	SDB-501A-RD Light Emitted Diode
J702	2090040	DIN Jack
S04	1110280	SSB02230 Slide Switch
CO701	2450050	} AC Outlet
CO702	2450050	
CO703	2450050	
F701	0431270	4A Power Fuse (100~117V)
	0431240	2A Power Fuse (220~240V)
	2300060	Fuse Holder

Parts No.	Stock No.	Description
T701	4002140	Power Transformer
PU01	2410080	Voltage Selector, socket
	2410090	Voltage Selector, plug
	2290100	4P Speaker Terminal
	3800020	Power Cord (KP-200)
	2230050	Ground Terminal

5-9. Other Parts (Bottom Side)

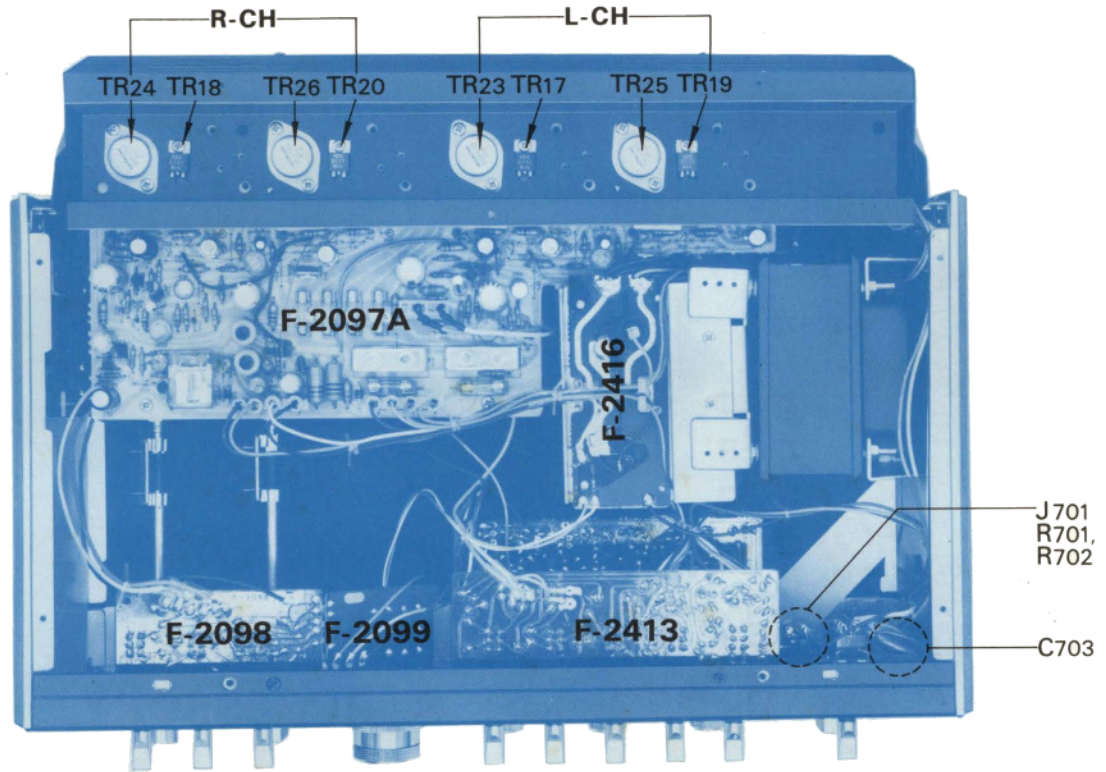

Parts List

Parts No.	Stock No.	Description
TR17	0308441, 2	2SD382 (M, L)
TR18	0308441, 2	2SD382 (M, L)
TR19	0303271, 2	2SB537 (M, L)
TR20	0303271, 2	2SB537 (M, L)
TR23	0306701	2SC898 (B)
TR24	0306701	2SC898 (B)
TR25	0300671, 2	2SA758 (B, C)
TR26	0300671, 2	2SA758 (B, C)
		} Transistor
C703	0659801	0.01 μ F 1.4kV C.C.
R701	0104221	220 Ω } 1W C.R.
R702	0104221	220 Ω }
J701	2430190	Headphone Jack

Abbreviations

- C.R. : Carbon Resistor
- S.R. : Solid Resistor
- Ce.R. : Cement Resistor
- M.R. : Metallized Film Resistor
- M.C. : Mylar Capacitor
- E.C. : Electrolytic Capacitor
- BP.E.C.: Bi-Polar Electrolytic Capacitor
- C.C. : Ceramic Capacitor
- Mi.C. : Mica Capacitor
- O.C. : Oil Capacitor
- P.C. : Polystyrene Capacitor
- T.C. : Tantalum Capacitor

6. REPLACEMENT OF POWER TRANSISTORS

- 1) Remove 4 pcs-screws installing on left (or right) side panel.
- 2) Remove 11 pcs-screws installing on bottom plate.
- 3) Remove all connectors and screws, ① and ② (See Fig. 6-1) installing on F-2097A.
- 4) Remove screw, ③, ④, ⑤ and ⑥ (See Fig. 6-2) installing heat sink.
- 5) Remove driver & power supply circuit board ass'y (F-2097A), then replace the transistors with new ones.

Fig. 6-1

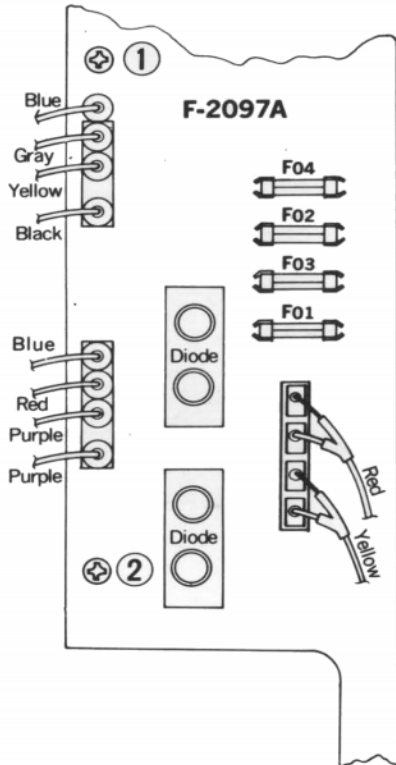
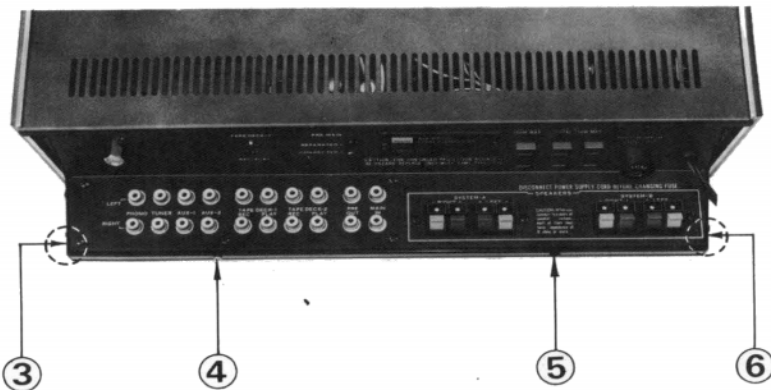
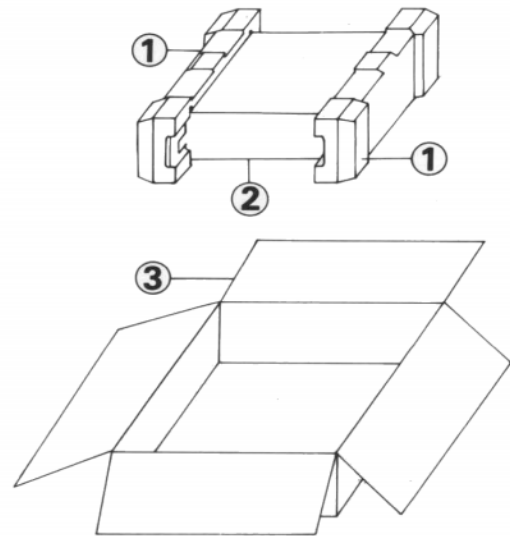

Fig. 6-2



7. PACKING LIST

Parts No.	Stock No.	Description
1	9027810	Stylofoam Packing
2	9116152	Vinyl Cover
3	9008111	Carton Case



8. ACCESSORY PARTS LIST

Stock No.	Description
0433630	4A Quick Acting Fuse
5066250	Pin Plug Cover
9208270	Operating Instructions
9228270	Operating Instruction Sheet

* Design and specifications subject to change without notice for improvements.

9. SCHEMATIC DIAGRAM

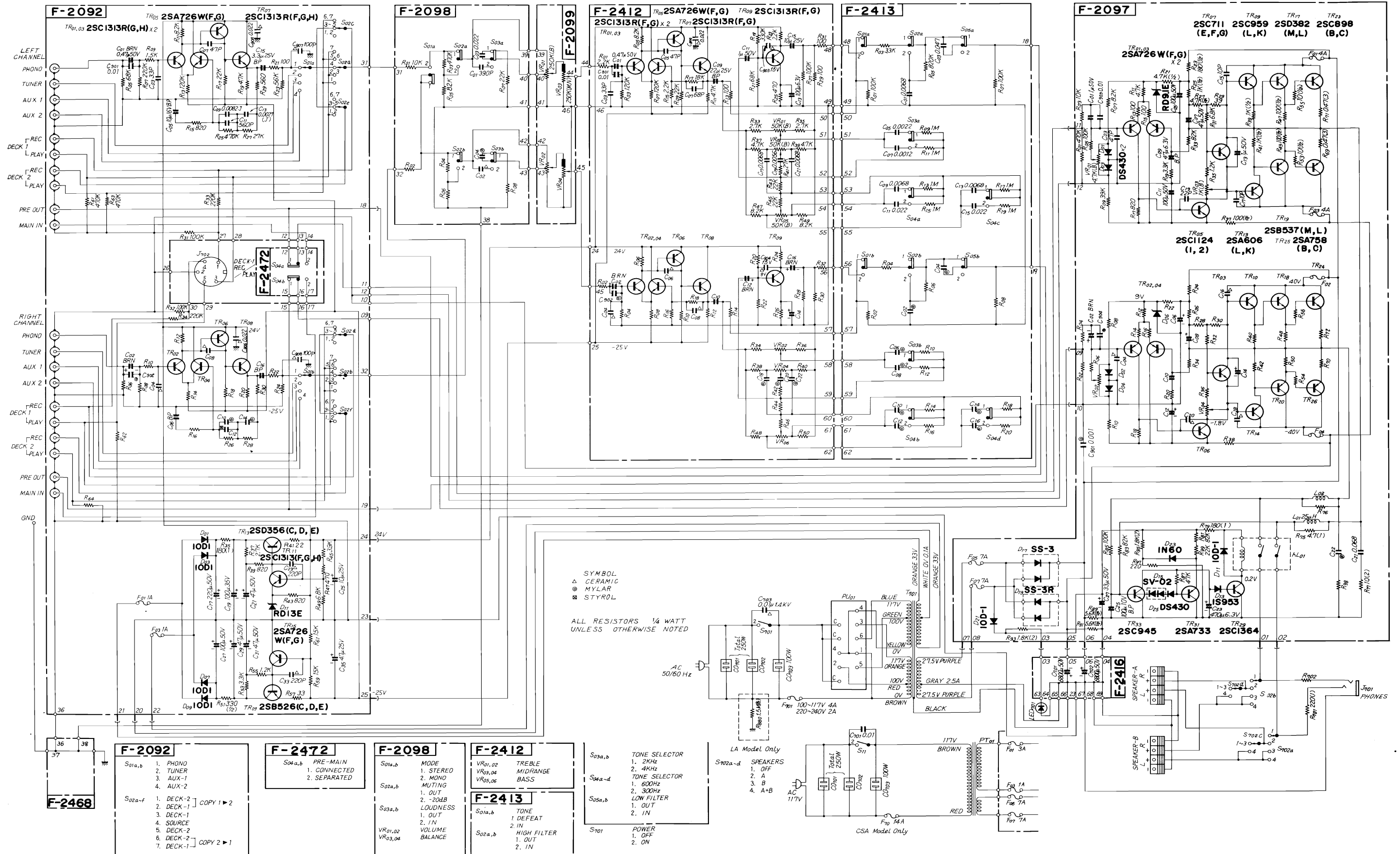



SANSUI ELECTRIC CO., LTD.

14-1, 2-chome, Izumi, Suginami-ku, Tokyo 168, Japan
TELEPHONE: (03) 323-1111/TELEX: 232-2076

SM027

Printed in Japan (94830M)